

:PARIS

Tavolini trasformabili



Praticità e bellezza sono irrinunciabili per chi cerca soluzioni brillanti, come il tavolo multiutility Paris. Riempie lo spazio con grazia trasformandosi con agilità da tavolino a tavolo, senza perdere il suo fascino.

Design : STUDIO SV

PARIS CT410

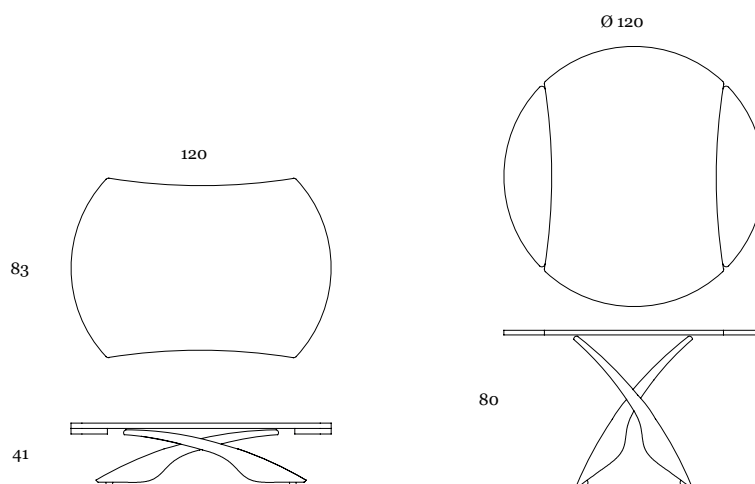

:MATERIALI | MATÉRIAUX | MATERIALS

:METALLO

Métal | Metal

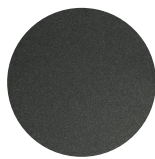

M11
Grafite goffrato



M19
Bronzo goffrato



M20
Nero goffrato



M23
Rosso vino goffrato



M24
Bianco goffrato



M25
*Verniciato rame
goffrato*



M27
*Verniciato menta
goffrato*

:LEGNO IMPIALLACCIATO

Bois placage | Veneered wood



W10
Noce canaletto

:VETRO

Verre | Glass

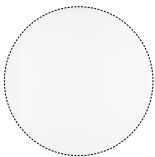

G04
Bianco acidato



G05
Tortora acidato

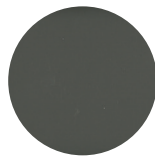

G10
Cenere acidato

:CERAMICA 3MM

Cèramique 3 mm | Ceramic 3mm



K01

*Fokos Sale
(Opaco)*

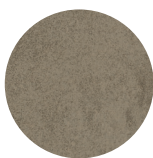

K02

*Fokos Terra
(Opaco)*

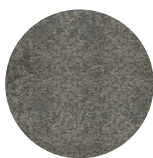

K03

*Fokos Piombo
(Opaco)*



K11

*Pietra Savoia Antracite
(Opaco)*



K15

*Noir Desir
(Opaco)*

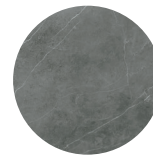

K16

*Pietra Grey
(Opaco)*



K17

*Calacatta Gold
(Opaco)*



K18

*Bianco Statuario
(Opaco)*



K19

*Diamond Cream
(Opaco)*

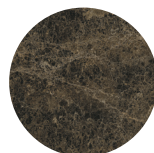

K20

*Emperador
(Opaco)*

:CERAMICA 5MM



K04

*Noir Desir
(Lucido)*

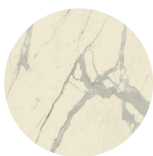

K05

*Bianco Statuario venato
(Lucido)*



K06

*Diamond Cream
(Lucido)*



K13

*Calacatta Gold
(Lucido)*



K22

*Calacatta Black lucidato Starlit
(Lucido)*

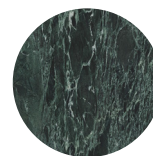

K23

*Verde Alpi
(Lucido)*



K24

*Cristallo Gold lucidato Starlit
(Lucido)*

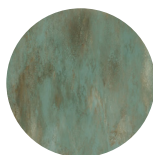

K25

*Ossido verderame
(Lucido)*



K26

*Cristallo Gold Caress
(Lucido)*